

Name _____

Tell-Tale Footprints

Mrs. Morton wants to know which of her three children—Mikie, Julie, or Charles—left the muddy footprints on her clean floor. Read the following clues and see if you can solve the mystery.

1. At 5:00 Mrs. Morton came home to find muddy footprints on the kitchen floor.
2. Charles was wearing size 11 tennis shoes that were very dirty.
3. Julie and Mikie were seen playing in a mud puddle on their way home from school at 4:00, but Julie was wearing overshoes.
4. Julie was seen entering the house by the back door at 4:50, looking very guilty.
5. Mikie supplied cookies to all the children in the neighborhood at 4:30, from Mrs Morton's cookie jar.
6. Charles came home from basketball practice at 5:05.
7. Julie went to Janet's house to play instead of going home to practice her piano.
8. When Charles got home Julie was playing the piano and Mikie was not home. Julie's overshoes were sitting on the back porch and her shoes were clean.
9. None of the children came in or left the house except as stated in clues 1 to 8.

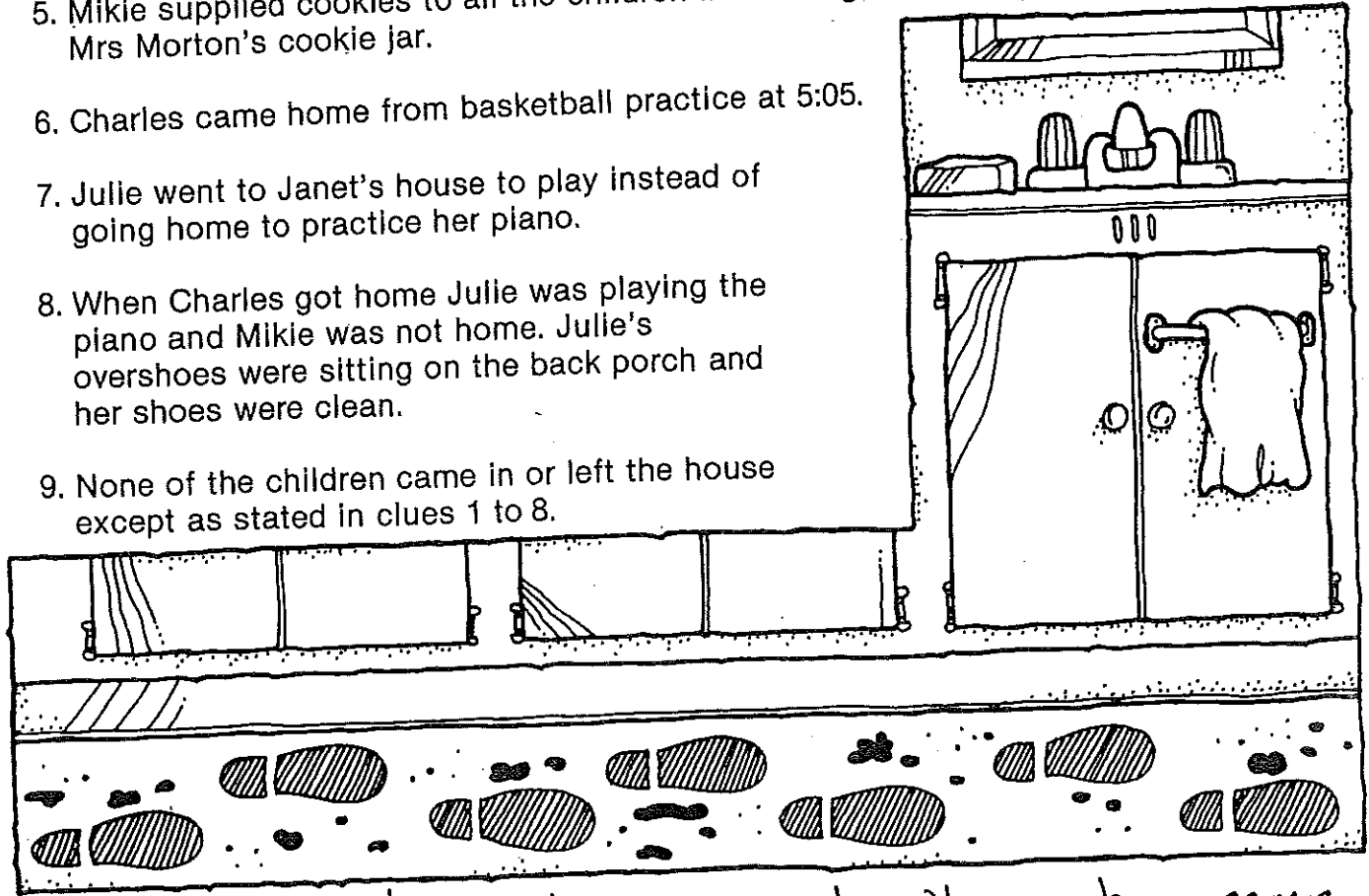

Solution Mikie tracked in mud when he came in to get cookies for the other children.

Name _____

Brown Bag Mystery

It's a mystery! Everyone would like to know what happened to Bianca's cookies. Read the following clues and see if you can find out what happened to the cookies.

1. An inspection at the lunch table showed that Carol had a bag of chocolate chip cookies in her lunch, but she said she did not take the cookies.
2. Bianca reported that her cookies were missing at the beginning of the lunch period.
3. Bianca found a tuna sandwich in her lunch.
4. Bianca's mother always fixes her peanut butter and jelly sandwiches.
5. Andy's mother had sent tuna.
6. Andy was seen entering the classroom at the first recess.
7. Andy, Carol and Bianca all like cookies and all three had their lunches in brown paper bags.
8. Carol was the first one to be excused to get her lunch.
9. Andy is allergic to oranges.
10. Bianca keeps her lunch in her desk.
11. Andy and Carol keep their lunches on the shelf at the back of the room.
12. Andy's lunch sack had a chicken sandwich, an orange, and oatmeal cookies.
13. Bianca was crying and wanted her lunch back, which she thought should include a peanut butter and jelly sandwich and cookies.
14. Carol's mother only sends oatmeal cookies.
15. Bianca had seen her mother pack chocolate chip cookies in her lunch.
16. Today's date is April 1.

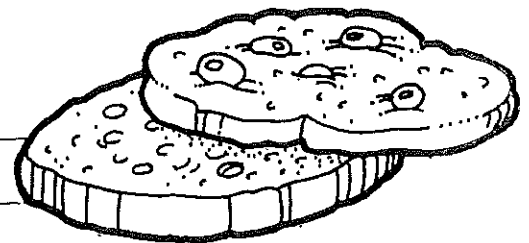
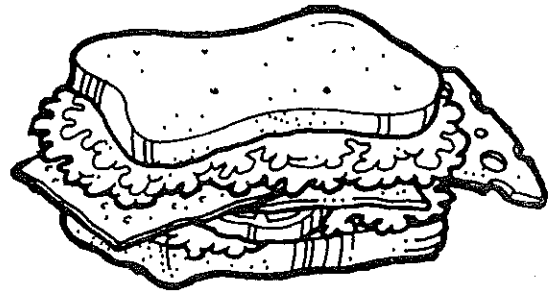

Solution Andy switched lunches with Bianca at recess as an April Fool's joke. Carol took Andy's lunch sack by mistake.

IL 21

Key

Name _____

Cubic Quandary

The same cube is shown ten times here, each time in a slightly different position. By comparing different views, determine which letter is on the bottom face of the cube. Write that letter in the blank below each view. If your work is correct, you will spell a common (and appropriate) ten-letter word.

1.

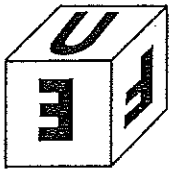

S

2.

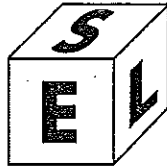

U

3.

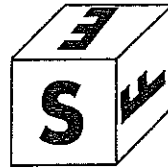

C

4.

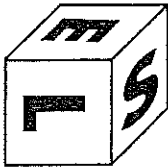

C

5.

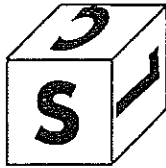

E

6.



S

7.

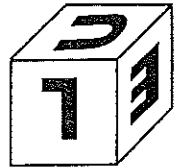

S

8.

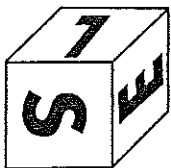

F

9.

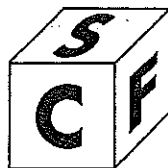

U

10.

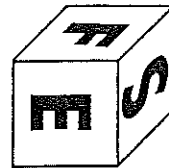

L

Think Inside the Box

DIRECTIONS: Circle the letter of each figure that belongs to the group in the box.

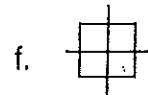
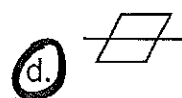
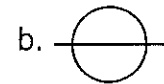
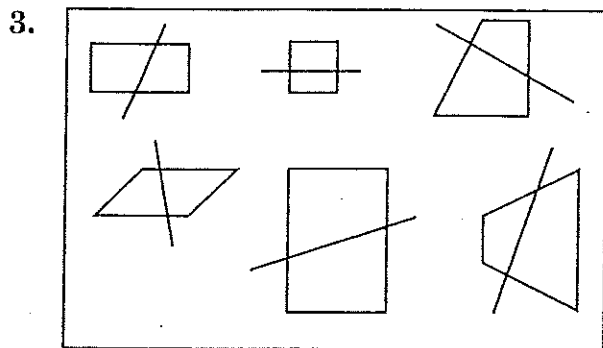
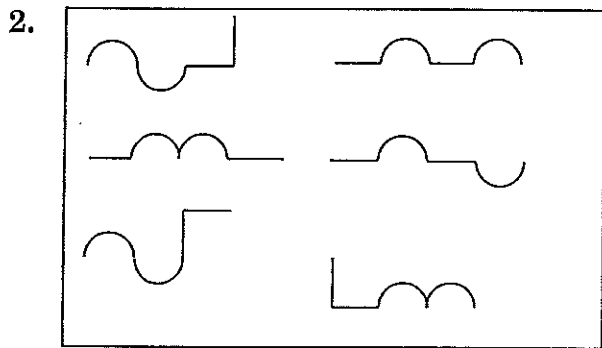
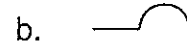
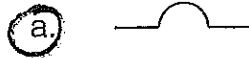
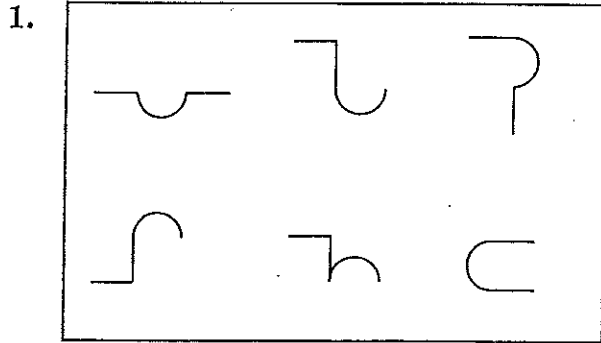

Camp-Out

Six friends went backpacking. Read the clues below to figure out which sleeping bag belongs to whom. Then write the name of each camper next to the correct bag.

Clues

1. Bruce and Walter are brothers, and are sleeping as far away from each other as possible.
2. Peter is next to Paul, but not next to Allen.
3. Allen is playing cards with Walter, who is closest to the logs.
4. Peter is a good friend of Bruce, but is not sleeping next to him.
5. Mark is next to Peter, but not next to Bruce.

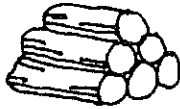

f. Bruce

a. Walter

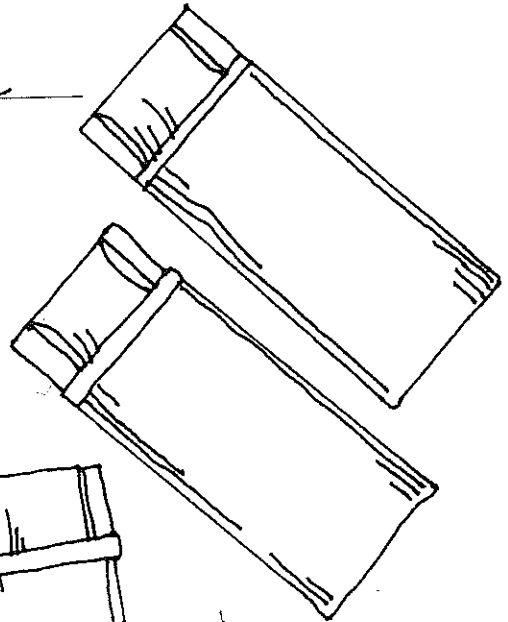
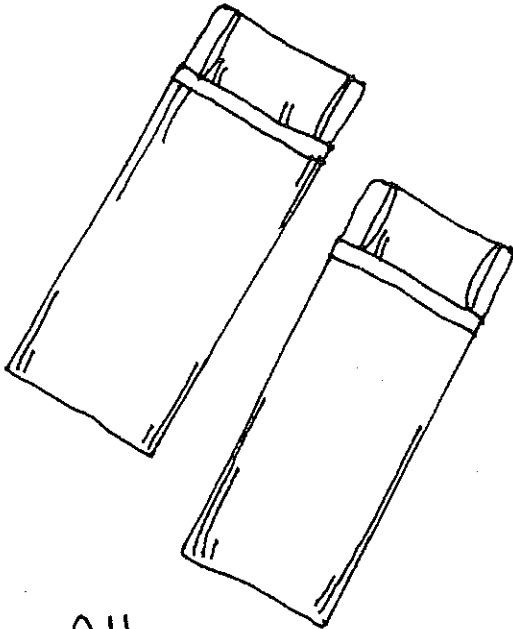

e. Paul

b. Allen

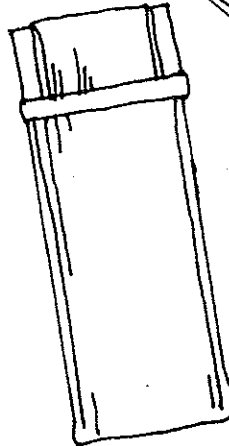
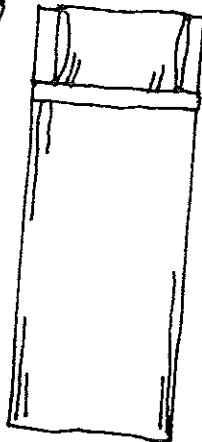

c. Mark

d. Peter

5/28

Key Windy 500

Have you ever heard of the Indy 500? Well, of course, you have! Have you ever heard of the Windy 500? It is a kite height race. The person who gets his or her kite to a height of 500 feet wins a \$50 gift certificate good at the local hobby store. Your job is to fly through these statements and deduce how each kite is decorated. When you have completed the puzzle, please decorate the kites and do not be afraid to be creative.

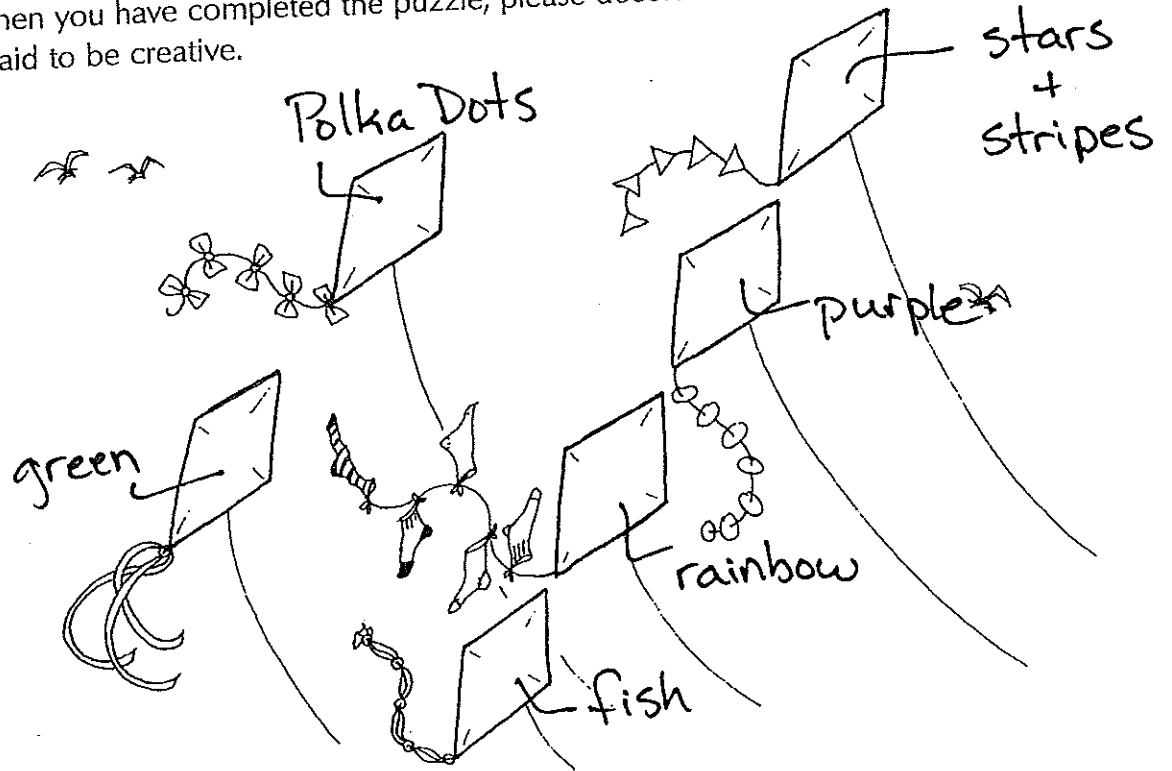

Facts:

1. There are six kites. They are decorated as follows: a rainbow, a fish, polka-dotted, stars and stripes, solid green, and solid purple.
2. Neither of the solid-colored kites won the race, and they are not side by side, nor are they directly behind each other.
3. The polka-dotted kite is higher than the green kite but below the stars and stripes kite.
4. The stars and stripes kite and the purple kite are higher than the rainbow and the green kite.
5. The stars and stripes kite and the fish kite are at the lowest and highest elevations.
6. The rainbow kite is directly above the fish kite.

IL
29

Key

Heads Up, Seven Up

During a recent benefit for disabled veterans, seven paratroopers from an Air Force base in Texas decided to show their stuff. They used their most colorful parachutes to put on quite a show. There were seven different colors of parachutes: purple, blue, green, orange, turquoise, red, and yellow. After you float through this logic, you should be able to identify the color of each parachute. Color each one appropriately.

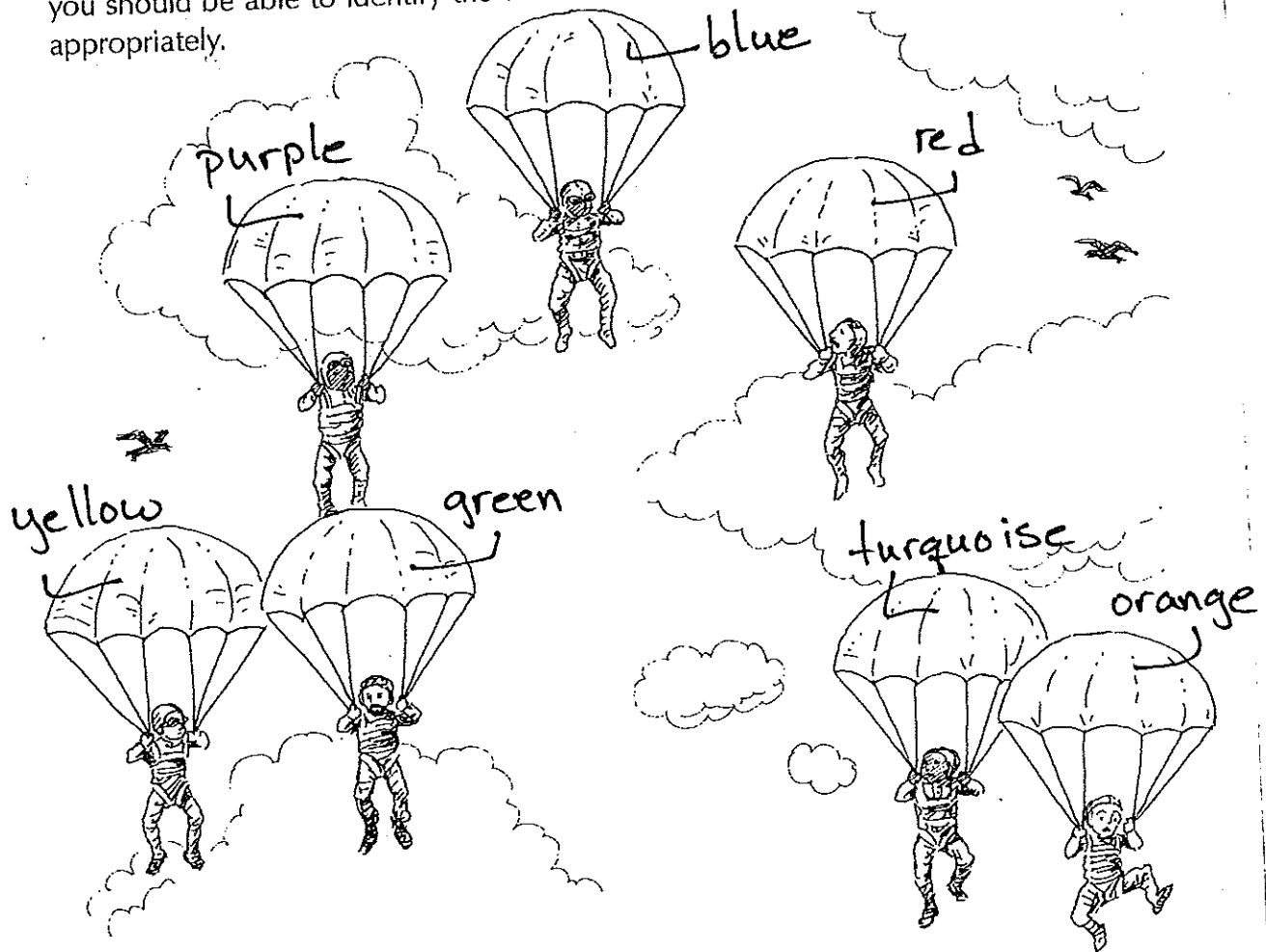

Facts:

1. The turquoise parachute is higher than the orange one but lower than the green one.
2. Purple and red are at the exact same height.
3. The blue parachute and the orange parachute are the highest and the lowest.
4. The purple parachute is directly above the green one.

Key

After-School Fun

DIRECTIONS: Two boys (Art and Brad) and two girls (Cindy and Della) each had their parents' permission to go to a certain after-school activity today. Find out where each person went (baseball practice, cheerleader tryouts, math club meeting, play rehearsal). Use the chart to help you. (Put "X" on squares showing what is NOT true and put checks on squares showing what IS true.)

1. Cindy did not go to baseball practice.
2. Brad wanted to go to the cheerleader tryouts but decided to go to a different activity instead.
3. The girl who went to the math club meeting told the club president that the meetings should not be held on the same day as so many other activities.
4. The person who went to baseball practice was upset because she couldn't attend the play rehearsal.

| | baseball practice | cheerleader tryouts | math club meeting | play rehearsal |
|-------|-------------------|---------------------|-------------------|----------------|
| Art | | X | | |
| Brad | | | | X |
| Cindy | | | X | |
| Della | X | | | |

56
31

Key

Shell Seekers

The Clinkingbeard family went looking for shells during their last visit to the beach. Out of respect for conservation, each family member agreed to take only one shell. Sift through these sandy facts and deduce who found what type of shell.

Facts:

1. Caleb looked for a cone shell but never found one.
2. Lucas found his shell at the same location where the oyster shell was found.
3. Kandy was excited when Josh found a razor clam.
4. Caleb and Randy's shells start with the same letter.

| | Conch | Cone | Razor | Oyster | Mollusk |
|--------|-------|------|-------|--------|---------|
| Joshua | | | X | | |
| Caleb | X | | | | |
| Kandy | | | | X | |
| Lucas | | | | | X |
| Randy | X | | | | |



12/32

Key

Disc Jockey Play-Off

A local radio station auditioned five new disc jockeys for their morning show. Each disc jockey plays a different type of music. Read the clues below. Then, on the grid at the bottom of the page, place an "X" to match each disc jockey with the type of music he or she plays.

Clues

1. Jenny went to the same college as both Slick and the new-wave disc jockey.
2. The rock-and-roll disc jockey auditioned before Jake, who auditioned second.
3. The new-wave disc jockey auditioned last, after Timmy.
4. The rhythm-and-blues disc jockey followed Slick, who was the first to audition.
5. Jenny left before Timmy's audition, because she doesn't like the country music that he plays.

| | Jenny | Slick | Betsy | Timmy | Jake |
|------------------|-------|-------|-------|-------|------|
| Jazz | X | | | | |
| Country | | | | X | |
| New Wave | | | X | | |
| Rock and Roll | | X | | | |
| Rhythm and Blues | | | | | X |

Name _____

Key

Name _____

The Snow Cone Man

Brian, Andrew, Mike, and Robby play together in the summer. When they hear the Snow Cone Man's bell, they run to ask their mothers if they may buy a cone. The boys are 9, 10, 10½, and 11 years old. Each friend likes a different flavor: grape, cherry, blueberry, and orange. Read the clues to find out each boy's age and favorite flavor of snow cone.

Clues

1. Andrew is older than Mike and the boy who likes blueberry but younger than the boy who likes orange.
2. The boy who likes blueberry is the youngest.
3. Brian and Andrew do not like grape.
4. Brian is not the oldest.

| | 9 years old | 10 years old | 10½ years old | 11 years old | grape | cherry | blueberry | orange |
|-----------|-------------|--------------|---------------|--------------|-------|--------|-----------|--------|
| Brian | X | | | | | | X | |
| Andrew | | | X | | | X | | |
| Mike | | X | | | X | | | |
| Robby | | | | X | | | | X |
| grape | | | | | | | | |
| cherry | | | | | | | | |
| blueberry | | | | | | | | |
| orange | | | | | | | | |

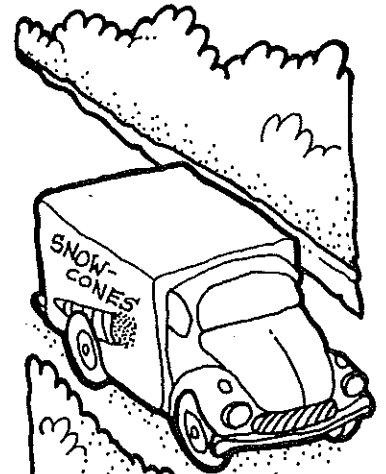

EL
34

Key

Video Rodeo

Five friends competed in five video games. Read the clues below. Then, on the grid at the bottom of the page, write the position each player finished in each event.

Clues

1. In each event, there was a first, second, third, fourth, and fifth finisher.
2. No one won more than two games, and there were no ties.
3. The winner of Spiderweb scored last in all the other games.
4. Michelle placed third in Trucker, ahead of both Creed and Marisa.
5. Marisa won Burnout but finished second in Fast Lane.
6. Jeremy won two games, the only two games in which Michelle finished third.
7. Michelle finished fifth in at least one game.
8. Marisa had one more fourth place finish than Michelle had.
9. One person finished second in four of the games, and won a fifth game.

| | Jeremy | Denise | Marisa | Michelle | Creed |
|--------------|--------|--------|--------|----------|-------|
| Spiderweb | 3 | 2 | 4 | 5 | 1 |
| Trucker | 1 | 2 | 4 | 3 | 5 |
| Fast Lane | 3 | 1 | 2 | 4 | 5 |
| Burnout | 3 | 2 | 1 | 4 | 5 |
| Night Flight | 1 | 2 | 4 | 3 | 5 |

11/35

Key

Party Favors

Christine had a small birthday party, and she gave out party favors. Read the clues below. Then, on the grid at the bottom of the page, place an "X" to match each person with the correct favors. You can use an "O" to mark a match that you know is incorrect.

Clues

1. Some friends got two favors, but no one got more than two.
2. No boy got something to eat.
3. At least two guests got candied apples.
4. No one had both candied apples and another thing to eat.
5. Amy refused to trade her fudge for Corey's trick candles.
6. Only one friend got a helium balloon, and he got nothing else.
7. John got two favors.
8. Only the friends with candied apples got puzzle books.
9. Noisemakers were the only favors that both a boy and a girl received.
10. Only two guests received only one favor.

| | Sarah | Lila | Amy | John | Corey | Walter |
|-----------------|-------|------|-----|------|-------|--------|
| Candied Apples | X | X | | | | |
| Noisemakers | | | X | X | | |
| Trick Candles | | | | X | X | |
| Fudge | | | X | | | |
| Helium Balloons | | | | | | X |
| Puzzle Books | X | X | | | | |

Name _____

36

Key

Fraction Action

Last week Mr. Tompkins gave a math quiz. Four of the top students scored 95 percent, each missing 1 of 20. Put your logic to work and figure out which student missed each problem; you need to find the fraction each one missed and its equivalent decimal.

| | $\frac{1}{8}$ | $\frac{7}{20}$ | $\frac{3}{8}$ | $\frac{4}{15}$ | .375 | .26 | .35 | .125 |
|--------|---------------|----------------|---------------|----------------|------|-----|-----|------|
| Joanna | | | X | | X | | | |
| Alex | X | | | | | | | X |
| David | | | | X | | X | | |
| Lydian | | X | | | | | X | |

Facts:

1. Joanna and Alex missed the problems with the same denominator.
2. Alex and Joanna had the largest and the smallest decimals. (Be careful with this one; be smart about decimals!)
3. David and Lydian each missed a problem with two decimal places.
4. Alex and Lydian missed the problems with the largest and the smallest numerators.

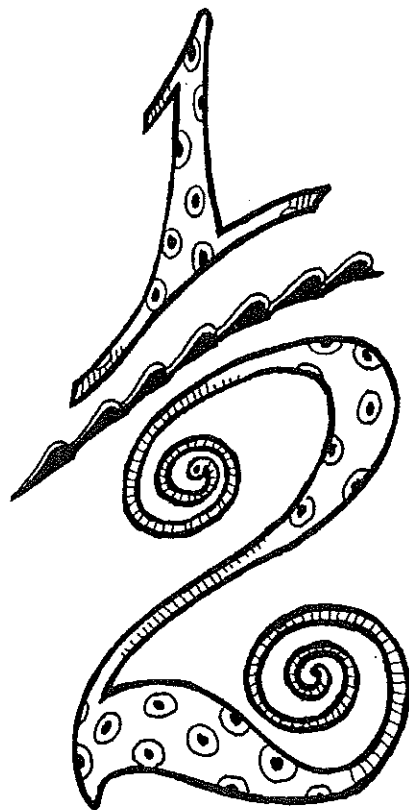

52
37

Key

Time Out!

Renate, John, Eric, Debbie, Manny, and Linda are all elementary school principals. Unfortunately, part of a principal's job has to do with putting students in "time out" for inappropriate behavior. Some days things are so hectic they feel like pulling their hair out, but they always return the next day with a smile. They relax and get refocused by taking their own "time out." Use the statements below to deduce their first and last names and what they do when they need "time out."

Facts:

1. Eric and Mr. Black went to college with the "divers."
2. Mrs. Schreiner and Renate both took time out by jumping into thin air.
3. The water sports were enjoyed by John and Mr. Valenzuela
4. The skydiver, Renate, and _____ Jehle are all females.
5. Mr. Black and Mr. Valenzuela always eat breakfast with the rollerblader and Debbie.
6. Mr. Abrahms, Linda, and the skydiver live on the same street.
7. Eric, Mr. Valenzuela, and the rollerblader are big Kansas University fans.

| | Black | Schreiner | Valenzuela | Jehle | Abrahms | Krompasky | Renate | John | Manny | Debbie | Linda | Eric |
|----------------|-------|-----------|------------|-------|---------|-----------|--------|------|-------|--------|-------|------|
| Go carts | | | | | X | | | | | | | X |
| Rollerblades | | | | X | | | | | | | X | |
| Bungee jumping | | | | | | X | X | | | | | |
| Water slides | X | | | | | | | X | | | | |
| Skydiving | | X | | | | | | | | X | | |
| Scuba diving | | | X | | | | | | X | | | |
| Renate | | | | | | | X | | | | | |
| John | X | | | | | | | | | | | |
| Manny | | | X | | | | | | | | | |
| Debbie | | X | | | | | | | | | | |
| Linda | | | | X | | | | | | | | |
| Eric | | | | | | X | | | | | | |

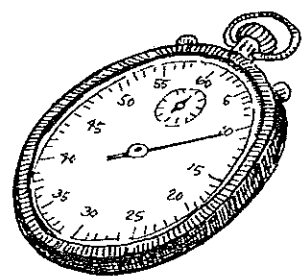

Key

The Zoo Trip

The sixth grade took a field trip to the zoo. Miss Busse appointed Ken, Kimberly, Brian, and Jennifer to be the leaders of the four groups. Each of the leaders had a different last name. The last names were Bouler, McCann, Roberts, and Dominguez. Each group also started their tour at a different location. One group started at Cat Country, one at Bear Pits, one at Primate House, and one at Reptile House. Use the clues to help you determine who lead each group and where they started their tours.

Clues

1. Ken, McCann, the boy who led group 2, and the girl whose group began at the Reptile House all had to keep track of the students in their group.
2. Dominguez, the girl who led group 3, the boy whose group began at the Bear Pits, and Jennifer all had a list of rules from Miss Busse.
3. Bouler led group 1 and started at the Reptile House.
4. Ken did not start at the Bear Pits or the Primate House.

| | Bouler | McCann | Roberts | Dominguez | group 1 | group 2 | group 3 | group 4 | Cat Country | Bear Pits | Primate House | Reptile House |
|---------------|--------|--------|---------|-----------|---------|---------|---------|---------|-------------|-----------|---------------|---------------|
| Ken | | | | X | | | X | X | | | X | |
| Kimberly | | X | | | | | X | | | X | | |
| Brian | | | X | | X | X | | | | X | | |
| Jennifer | X | | | | X | | | | | | | X |
| group 1 | | | | | | | | | | | | |
| group 2 | | | | | | | | | | | | |
| group 3 | | | | | | | | | | | | |
| group 4 | | | | | | | | | | | | |
| Cat Country | | | | | | | | | | | | |
| Bear Pits | | | | | | | | | | | | |
| Primate House | | | | | | | | | | | | |
| Reptile House | | | | | | | | | | | | |



Key

We Be Jammin'

These brown baggers never eat lunch in the cafeteria. They cannot go through a day without their peanut butter and jelly sandwiches. Spread out the logic here as you munch through the facts to deduce who likes what kind of "jam" on peanut butter and which type of bread each prefers.

Facts:

1. Sara and the wheat-berry eater are cousins to the marmalade lover and Brandon.
2. Jesse does not like apples or strawberries, but he loves wheat bread.
3. Christina and the croissant eater love apples.
4. The strawberry eater likes crushed wheat bread.
5. Grapes are favored by the croissant eater and Brandon.
6. Brandon, Christina, and the apple/grape eater do not like any kind of wheat bread.
7. Christina does not like sourdough, but Nick likes wheat-berry bread.

| | Whole Wheat | Wheat-berry | Crushed wheat | White | Sourdough | Croissant | Raspberry | Marmalade | Grape | Apple | Apple/Grape | Strawberry |
|-------------|-------------|-------------|---------------|-------|-----------|-----------|-----------|-----------|-------|-------|-------------|------------|
| Keegan | | | X | | | | | | | | | X |
| Brandon | | | | | X | | | | X | | | |
| Jesse | X | | | | | | | X | | | | |
| Christina | | | | X | | | | | | X | | |
| Nick | | X | | | | | X | | | | | |
| Sara | | | | | | X | | | | | X | |
| Raspberry | | X | | | | | | | | | | |
| Marmalade | X | | | | | | | | | | | |
| Grape | | | | | X | | | | | | | |
| Apple | | | | X | | | | | | | | |
| Apple/Grape | | | | | | X | | | | | | |
| Strawberry | | | X | | | | | | | | | |

